



# POWASTONE

**Shandong Huison Electronics Technology Co., LTD**

---

## **PS-10016S**

**(RCN-10016S Product Specification)**

Product Name	51.2V100A BMS
Product Model	PS-10016S
Version	V6.0
Certificate	IEC62619, UL1973

Address: No.10 West Keda Road, Yicheng District, Zaozhuang City, Shandong Province China

Tel:0086-0632-7526626

[www.huisonbattery.com](http://www.huisonbattery.com)

### Change Record

Version number	Date	Change the content	Change	Examine and verify	Ratify
V1.0	2019/7/11	V1.0			
V1.2	2020/5/14	V1.2			
V1.2.1	2021/7/21	V1.2.1			
V1.3.1	2022/11/17	V1.3.1			
V2.0	2023/4/10	V2.0			
V6.0	2024/3/27	V6.0			

## 1.Product description

---

With the wide application of lithium iron battery in the Residential energy storage industry, We designed the battery management system (BMS) with high reliability and performance, and solve the problems during installing, save the labor cost by reduce the installing time and debugging times.

This product has wide compatibility, supporting 8-16 series cell in series.For 8S batteries, simply connect the battery cell monitoring cables to the 8th battery cell , and modify the number of strings and corresponding protection values from the PC software.

This BMS are compatible with various inverters and support customized protocol. In order to ensure the safety of use and prolong the service life of the battery, this product supports multi-layer protection, a series of protection and recovery functions, such as over-voltage/under-voltage protection for battery cells, high-temperature protection for charging/discharging, low-temperature protection for charging/discharging, over-current protection for charging/discharging, and short circuit protection, Pre charging, RPSD(Rapid shut down), Auto DIP(Address) setting,Active balancing,etc.

This product also has high precision sampling and calculation characteristics, such as high voltage accuracy (5mV),7-way temperature detection (1°C), SOC, SOH estimation function (1%), etc. The BMS can communicate with the PC software through RS485 protocol, on which the data can be monitored or the relevant protection value can be configured.

This BMS can communicate with the inverter via the CAN or 485 protocol.

## 2.Normative document references

---

The following documents are essential for the application of this document. For all dated references, only the dated version applies to this file. For unspecified references, the latest version (including all modifications) applies to this file.

GB/T 191	Packaging, storage and transportation drawing sign
GB/T 2408-2008	Determination of plastic combustion properties, horizontal and vertical methods
EN 61000-6	Electromagnetic compatibility test and measurement technology surge (impact) immunity test
GB/T 17626.5-2008	Electromagnetic compatibility test and measurement technology surge (impact) immunity test
GB/T 17626.2-2006	Electromagnetic compatibility test and measurement technology electrostatic discharge immunity test
YD/T 2344.1-2011	Lithium iron phosphate battery pack for communication- -Part 1: Integrated battery pack

- YD/T 2344.2-2015 Lithium iron phosphate battery pack for communication- -Part 2: Discrete battery pack
- YD/T 1363.3 Power supply, air conditioning and environment centralized monitoring and management system of communications Administration (station) - -Part 3: Front-end intelligent equipment protocol
- GB/T 36558-2018 General technology for energy storage system

### 3.System chart

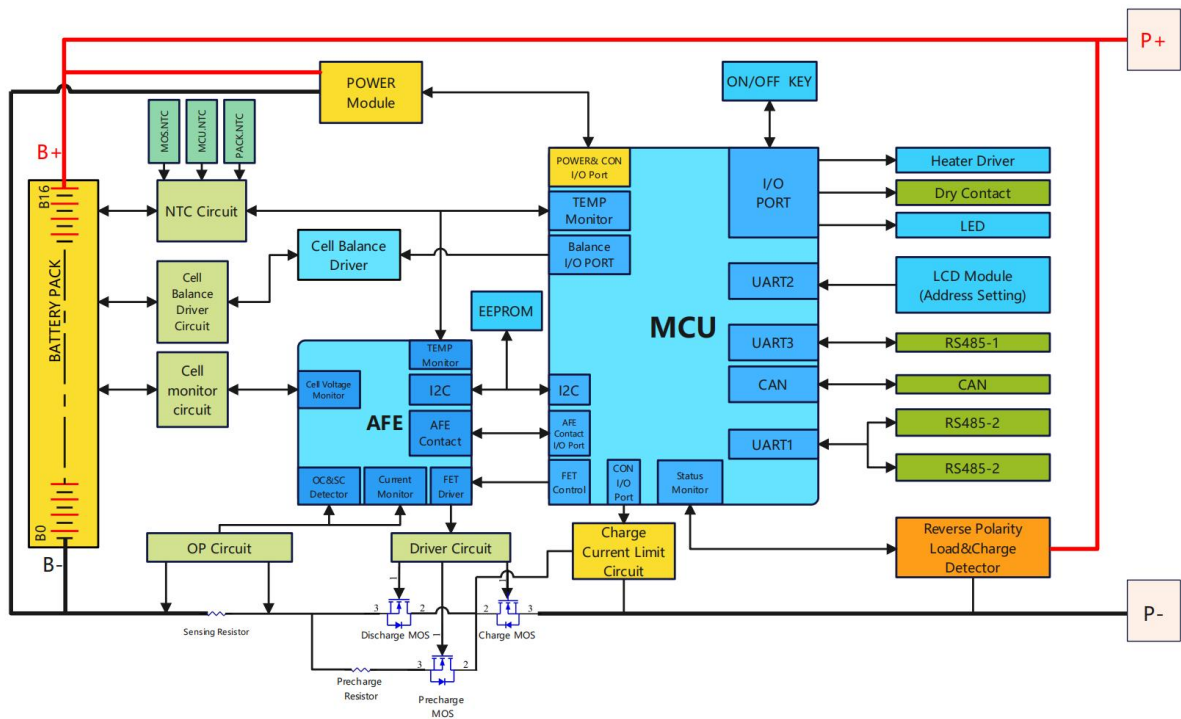

## 4.Functional characteristics

High-integrated analog front-end	Adjustable over-current protection
Isolation power circuit	Low power consumption
Integrated serial port IC	Dual-channel RS485 communication
High Voltage Precision (5 mV)	Parameter Adjustable Settings
High current accuracy (2%@FS)	The LED status indication function
7-way temperature detection (1℃)	Passive equilibrium
SOC estimation Function (1%)	Short circuit protection function
SOH estimation function (1%)	1A active balancing
Touch screen control	British software support(Pending)

## 5.Mechanical dimension

### 5.1 Dimensional drawing

Length \* width =250mm \*80mm

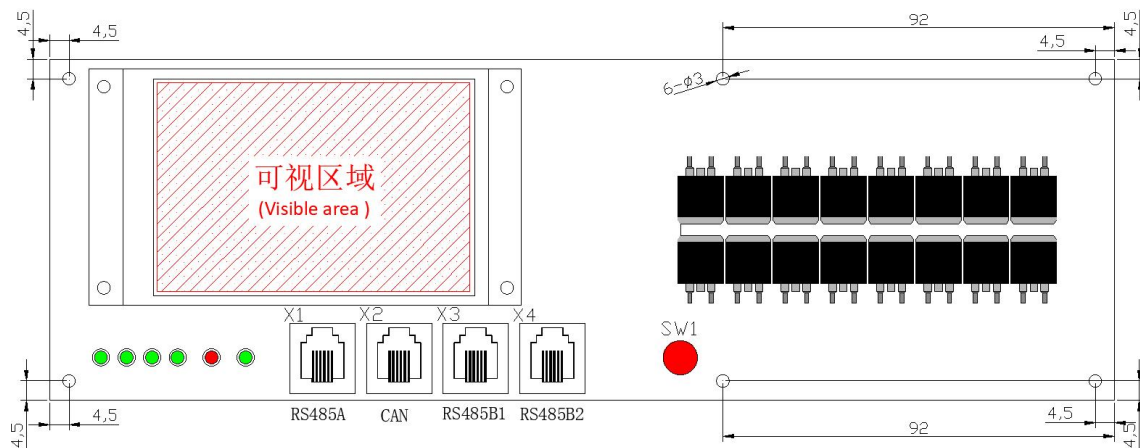

Front dimension diagram

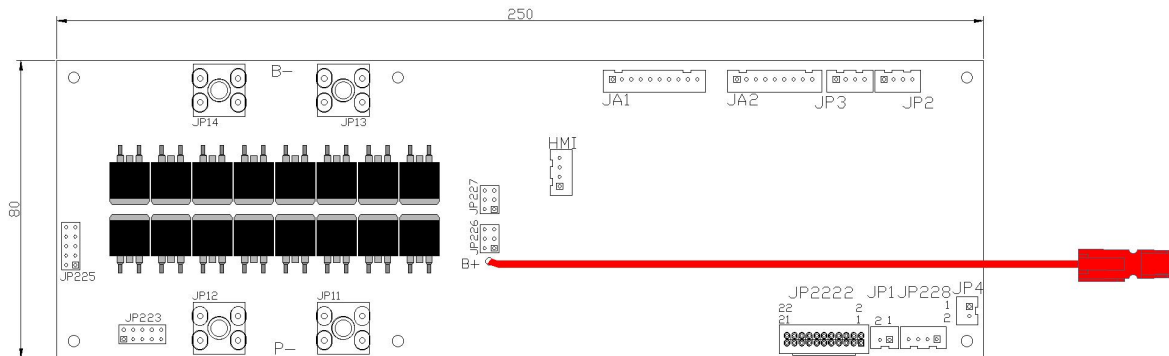

Reverse dimension diagram

## 5.2 Electrical characters

Item	Parameter	Unit
Working temperature	-20~75	°C
Storage temperature	-20~75	°C
Working humidity	10~85	%RH
Storage humidity	10~85	%RH
Working voltage	40~59	V
Charging voltage	48~60	V
Discharge current	0~100	A
Internal resistance	< 2	mΩ

## 6.Interface

### 6.1 Interface Definition

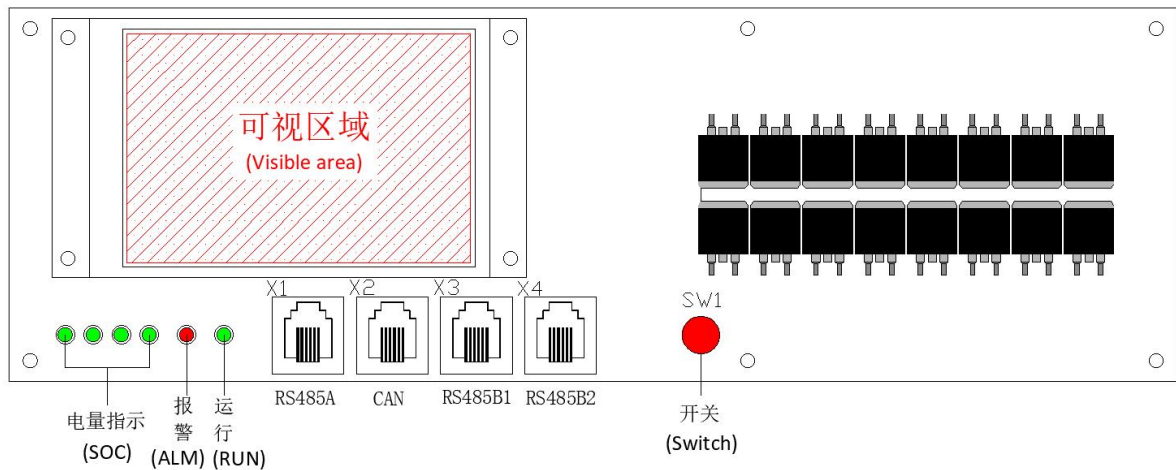

Front interface definition

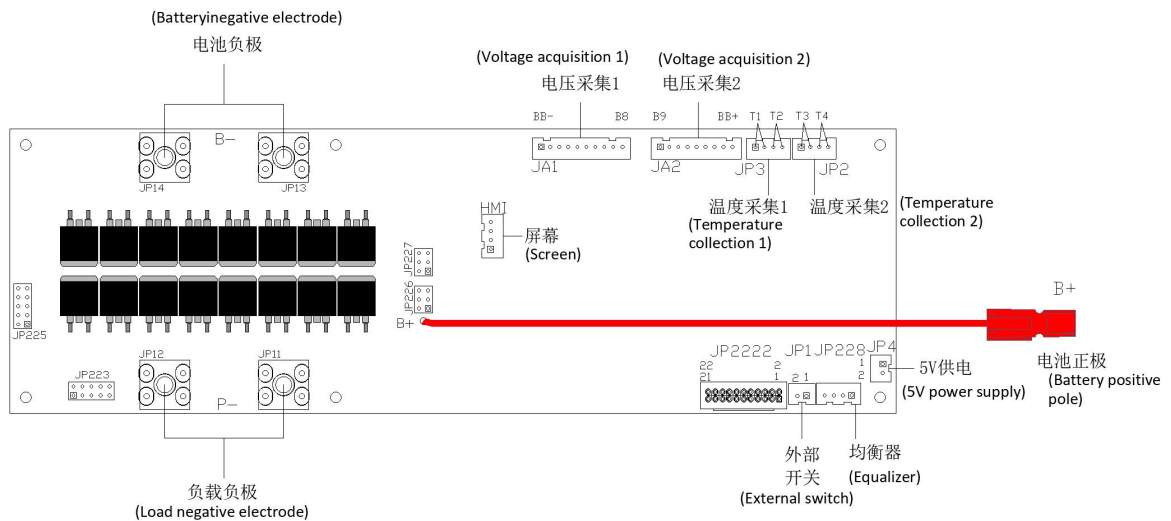

Definition of reverse interface

## 6.2 Harness definition

<b>Harness 1 (JA1 on BMS)</b>		
<b>NO.</b>	<b>BMS Wiring definition</b>	<b>Definition of cell wiring</b>
1	BB-	(Connect to the negative electrode of section 1st cell)
2	B0	(Connect to the negative electrode of section 1st cell)
3	B1	(Connect to the positive electrode of section 1st cell)
4	B2	(Connect to the positive electrode of section 2nd cell)
5	B3	(Connect to the positive electrode of section 3rd cell)
6	B4	(Connect to the positive electrode of section 4th cell)
7	B5	(Connect to the positive electrode of section 5th cell)
8	B6	(Connect to the positive electrode of section 6th cell)
9	B7	(Connect to the positive electrode of section 7th cell)
10	B8	(Connect to the positive electrode of section 8th cell)
<b>Harness 2(JA2 on BMS)</b>		
<b>NO.</b>	<b>BMS Wiring definition</b>	<b>Definition of cell wiring</b>
1	B9	(Connect to the positive electrode of section 9th cell)
2	B10	(Connect to the positive electrode of section 10th cell)
3	B11	(Connect to the positive electrode of section 11th cell)
4	B12	(Connect to the positive electrode of section 12th cell)
5	B13	(Connect to the positive electrode of section 13th cell)
6	B14	(Connect to the positive electrode of section 14th cell)
7	B15	(Connect to the positive electrode of section 15th cell)
8	B16	(Connect to the positive electrode of section 16th cell)
9	BB+	(Connect to the positive electrode of section 16th cell)
<b>Harness 3(JP1 on BMS) (Optional)</b>		
<b>NO.</b>	<b>BMS Wiring definition</b>	<b>Definition of switch wiring</b>
1	1	Switch positive
2	2	Switch negative
<b>Wire harness 3-4 (JP2, JP3 on BMS)</b>		
<b>NO.</b>	<b>BMS Wiring definition</b>	<b>Interface Definition</b>
1	T1-T2、 T3-T4	Temperature sensors



**Actual wiring mode diagram of sampling line and battery cell**

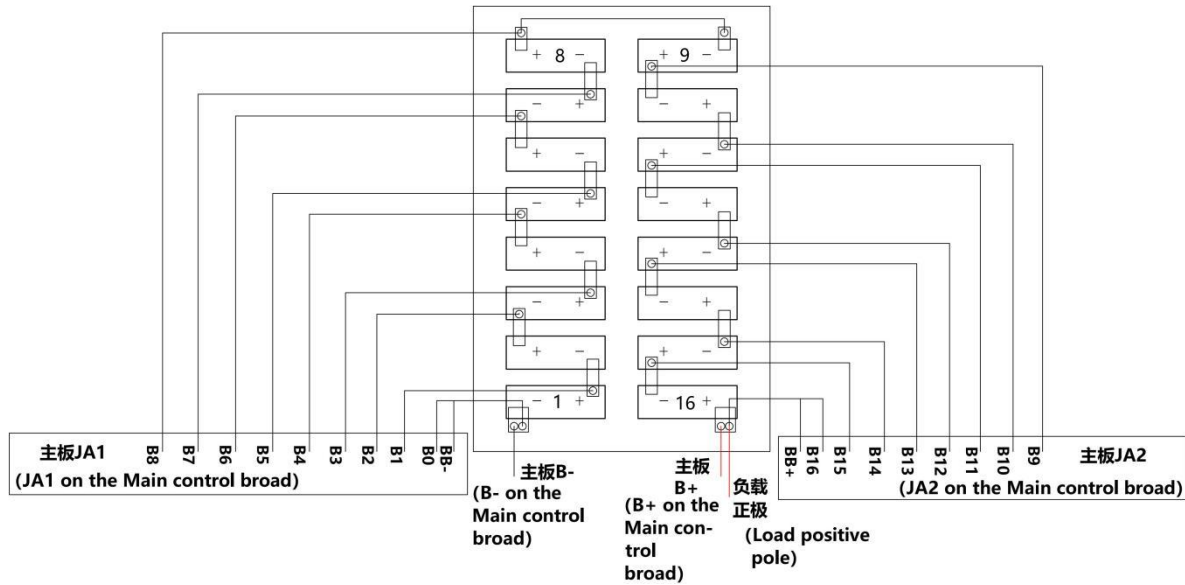

### 6.3 Installation instructions

- ◆ Connect the BMS in sequence, follow B-, JA1, JA2, JP2,JP3, B+, JP1 (if has),P-.
- ◆ Recharge the battery or activate the switch.
- ◆ Disconnect the charger or load, turn off the BMS witch, remove P-, JP1 (if any), B+, JP3,JP2, JA2, JA1, B- in sequence.

### 6.4 Communication

#### 6.4.1 Inverter communication, PC software communication, and remote upgrade)

Due to the various inverter products, attention should be paid to the corresponding communication interface when matching. Special inverter communication interface definition is different, need to bring their own network cable.

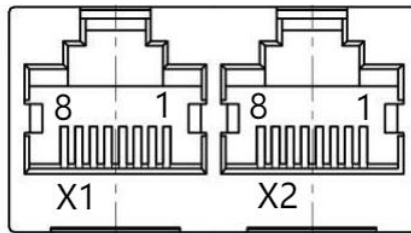

RS485 and CAN port

RS485--(PC communication, 485 upgrade (X1))		CAN -Inverter CAN/RS485 communication (X2)	
(Pin)	Definition	(Pin)	Definition
PIN1	(Empty)	PIN1	(Empty)
PIN2	(Empty)	PIN2	(Empty)
PIN3	RS485A1	PIN3	(Empty)
PIN4	(Empty)	PIN4	CAN-BUSH
PIN5	RS485B1	PIN5	CAN-BUSL
PIN6	(Empty)	PIN6	(Empty)
PIN7	(Empty)	PIN7	RS485A1
PIN8	(Empty)	PIN8	RS485B1

#### 6.4.2 Parallel batteries communication

Select the corresponding port for BMS internal communication. When parallel batteries, a direct interconnection network cable (T568B-T568B) is required.

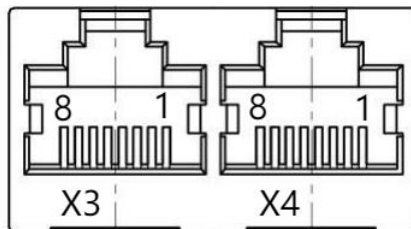

RS485- -Parallel communication			
Pin (X3)	Definition	Pin (X4)	Definition
PIN1	Empty	PIN1	Empty
PIN2	DI	PIN2	DI
PIN3	A-PACK parallel connection	PIN3	A-PACK parallel connection
PIN4	GNDDI	PIN4	GNDDI
PIN5	B-PACK parallel connection	PIN5	B-PACK parallel connection

PIN6	IO1	PIN6	IO2
PIN7	Empty	PIN7	Empty
PIN8	DGND	PIN8	DGND

## 7. Operating instructions of the PC software

### 7.1 PC software connection and monitoring

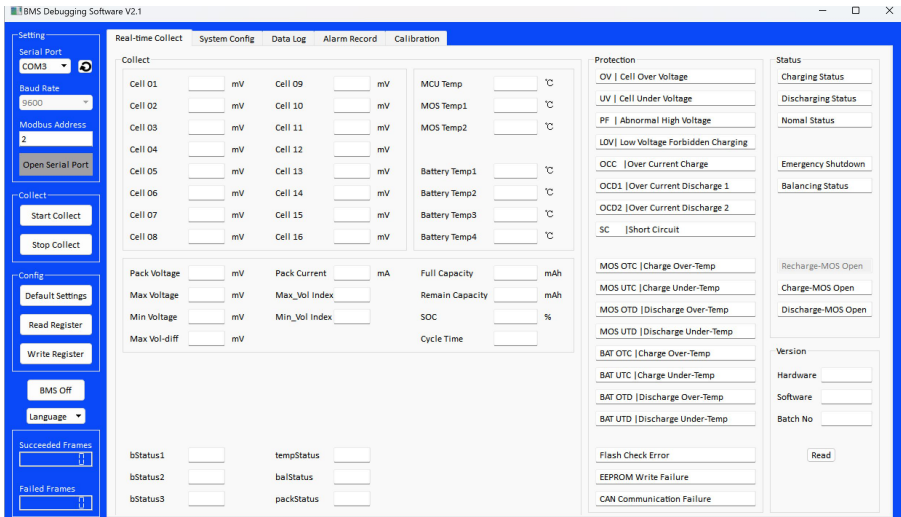
<p>1. Open the <b>PC software</b></p>	
<p>2. Click to set port parameters (may different COM), and the corresponding MODBUS address and port rate <b>9600</b>, click to <b>open serial port</b>.</p>	
<p>3. After completing the serial port configuration, click to <b>Start collect</b>, and the current real-time data can be displayed in the the main interface.)</p>	

## 7.2 Parameter configuration

After selecting **system config page**, click the **read register** button to start reading the original configuration of the device. After completing the reading, the configuration of the device can be modified. After confirming the modification, click the **write register** to complete the configuration modification (Click the default parameter button to reset the configuration to the default value)

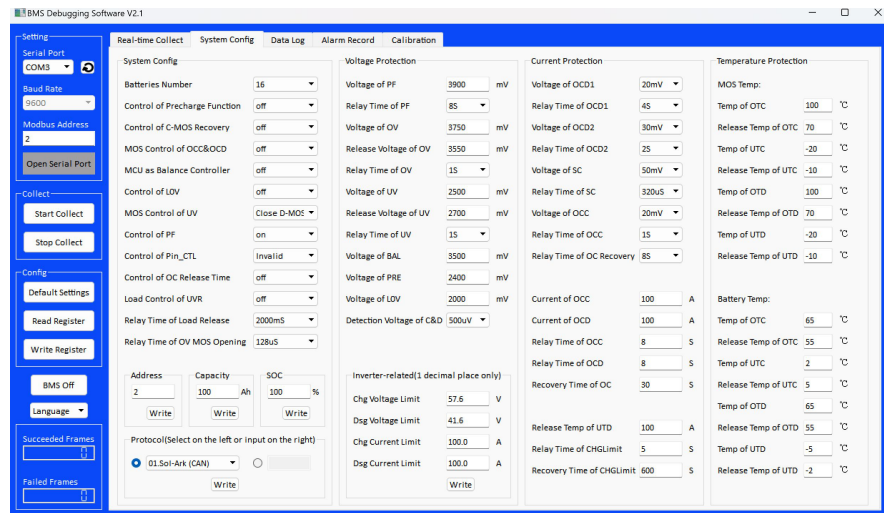

## 7.3 Calibration and Records

After selecting the calibration page, charge the battery, set the charging current to 0A, conduct zero point calibration, and then set the charging current to 40A for gain calibration.

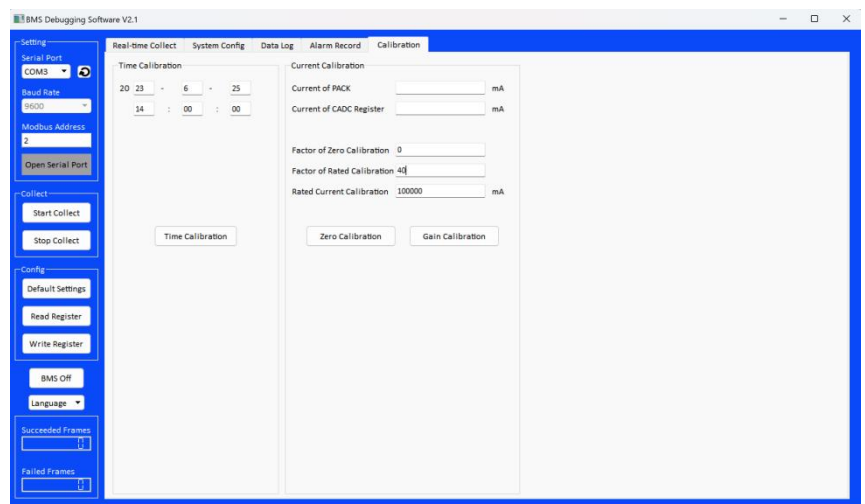

After selecting the data log, click on "Start" to view the alarm records (up to 50 records can be stored).

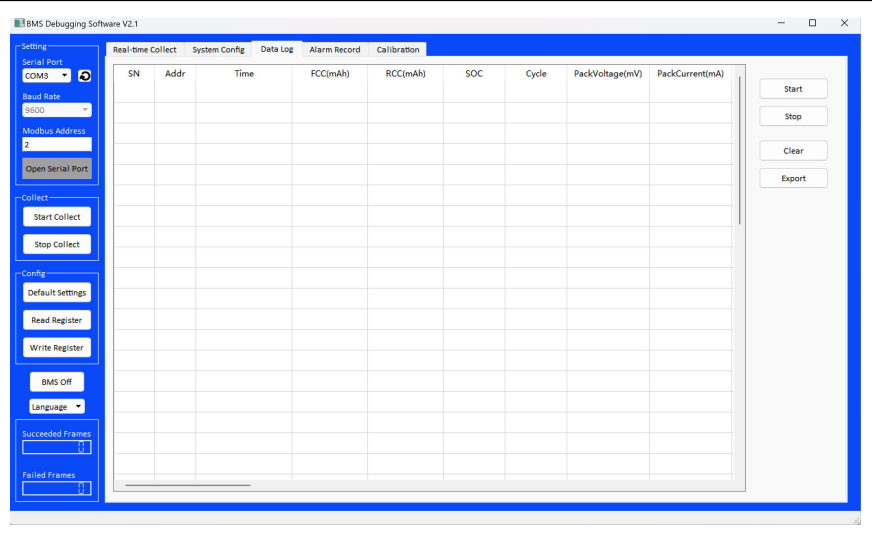

## 8.LED indicator instructions

Work indication status is shown in the table

State	Normal / Alarm / Protection	Power quantity indicates the LED				Alarm indicator	Run	Definition
Shut down	Sleep	Off	Off	Off	Off	Off	Off	All off
Charge	Normal	According to the SOC				Off	Flash	
	Alarm	According to the SOC				ON	Flash	Stop charging
	Overcharge protection	ON	ON	ON	ON	ON	Flash	Stop charging
	Temperature, overcurrent, and failure protection	According to the SOC				ON	(Flash)	Stop charging
Normal	Off					Flash		
Discharge	Alarm	According to the SOC				ON	Flash	Stop discharge
	Over-discharge protection					ON	ON	ON
	Temperature, overcurrent, and failure protection	According to the SOC				ON	(Flash)	Stop discharge

## 9.Parameter setting

	Items	Set up	Whether can set	Remarks
System configuration	Battery serial number	16-string-b'0000	(Can set)	
	Pre-charging control	off	(Can set)	
	Charging MOS recovery control	on	(Can set)	
	Charge-discharge and overcharge MOS control	on	(Can set)	
	The MCU balance controls	on	(Can set)	
	Low-voltage prohibited charging is enabled	off	(Can set)	
	Over-discharge MOS control	close-discharge MOS	(Can set)	
	Abnormal high voltage protection	on	(Can set)	
	The CTL pin control	Chg/Dsg	(Can set)	
	Current protection for timing recovery	on	(Can set)	
	Over-discharge recovery load lock	on	(Can set)	
	Load release delay	2000ms	(Can set)	
	Charge / discharge MOS open delay	128μs	(Can set)	
	Write BMS address	2	(Can set)	
	Write battery capacity	100Ah	(Can set)	
Write SOC	100%	(Can set)		
Current protection	(Discharge over-current 1 protection voltage	20mV	(Can set)	
	Over-current discharge 1 protection delay	4s	(Can set)	
	Discharge over-current 2 protection voltage	30mV	(Can set)	
	Discharge over-current 2 protection delay	2s	(Can set)	
	Short circuit protection voltage	50mV	(Can set)	
	Short circuit protection delay	320μs	(Can set)	
	Charge the over-current protection voltage	20mV	(Can set)	
	Charge over-current protection delay	1s	(Can set)	

		Overcurrent auto-recovery delay	8s	(Can set)	
		Charging over-current protection	100A	(Can set)	
		Discharge over-current protection	100A	(Can set)	
		Charging over-current protection time	8s	(Can set)	
		Discharge over-current protection time	8s	(Can set)	
		Over-current protection recovery delay	30s	(Can set)	
		Current limiting board protection current	100A	(Can set)	
		current limit protection time	5s	(Can set)	
		Current limiting protection recovery time	600s	(Can set)	
Voltage protection		Abnormal high-voltage protection voltage	3900mV	(Can set)	
		Abnormal high-voltage protection time delay	8s	(Can set)	
		Over-voltage protection voltage	3750mV	(Can set)	
		Over-voltage protection release voltage	3550mV	(Can set)	
		Over-pressure protection delay	1s	(Can set)	
		Under voltage protection voltage	2500mV	(Can set)	
		Under-voltage protection release voltage	2700mV	(Can set)	
		Under voltage protection delay	1s	(Can set)	
		Balance open voltage	3500mV	(Can set)	
		Pre-charge turn open voltage	2400mV	(Can set)	
		Low voltage is prohibited charging voltage	2000mV	(Can set)	
		Charge and discharge state detection voltage	500μV	(Can set)	
		Inverter charge limit voltage	57.6V	(Can set)	
		Inverter discharge limit voltage	41.6V	(Can set)	
		Inverter charge current limit	100A	(Can set)	
	Inverter discharge current limit	100A	(Can set)		
Temperatur	MOS temperatu	Charging high temperature protection	100℃	(Can set)	

e protection	re	Charging high temperature protection release	70°C	(Can set)	
		Charging low temperature protection	- 20°C	(Can set)	
		Charging low-temperature protection release)	- 10°C	(Can set)	
		Discharge high temperature protection	100°C	(Can set)	
		Discharge with high temperature protection release	70°C	(Can set)	
		Discharge low temperature protection	- 20°C	(Can set)	
		Discharge low temperature protection release	- 10°C	(Can set)	
	Battery temperature	Charging high temperature protection	65°C	(Can set)	
		Charging high temperature protection release	55°C	(Can set)	
		Charging low temperature protection	2°C	(Can set)	
		Charging low-temperature protection release)	5°C	(Can set)	
		Discharge high temperature protection	65°C	(Can set)	
		Discharge high temperature protection release	55°C	(Can set)	
		Discharge low temperature protection	-5°C	(Can set)	
		Discharge low temperature protection and release)	-2°C	(Can set)	

## 10.Function Description

### 10.1 Turn on / off

Number	Function	Definition
1	Turn on	In the off state, press the switch, the indicator light is on, and the BMS enters the working state
2	Turn off	In the working state, press the switch, the indicator goes off, and the BMS enters off state



## 10.2 Voltage detection and protection

Number	Function	Definition
1	Voltage detection	The voltage detection accuracy is $\leq 5\text{mV}$ , min 0.1A detected.
2	Single cell over-voltage protection	Any of the cell reaches the cell over-voltage protection value, the BMS turns off the charging MOS and stops charging. If the voltage reaches the recovery value or starts the discharge, Auto remove the over-voltage protection.
3	Single cell under-voltage protection	Any of the cell reaches the single cell under-voltage protection value, the BMS closes the discharge MOS and stops discharging. If the voltage reaches the recovery value or starts the charge, release the protection.
4	Abnormal high voltage protection	Any of the cell reaches the abnormal high voltage protection value, the BMS turns off the charging mos and stops charging. If the voltage reaches the recovery value or starts the discharge, release protection.
5	Low voltage prohibited charging protection	Any one cell reaches the low voltage prohibited charging voltage protection value, BMS closes the charging mos and stops charging. If the voltage reaches the recovery value then release the protection.

## 10.3 Current detection and protection

Number	Function	Definition
1	Current detection	Voltage detection accuracy $\leq 2\% @ \text{FS}$
2	Charging over-current protection	When there is no charge current limiting function, the current reaches the charge over-current protection value and reaches the delay time, BMS closes the charging mos and stops charging. BMS reaches the recovery delay and release the protection.
3	Discharge over-current protection	Current reaches the discharge over-current protection value and reaches the delay time. BMS closes the discharge mos and stops the discharge. BMS reaches the recovery delay and release the protection.
4	Short-circuit protection	When voltage value reaches SCP and the delay time is reached, the short-circuit protection is activated; After the short-circuit voltage gradually disappears, the protection is released after load discharging.
5	Charging limit	Reaching the set value and the delay time, activate charging current limiting; After reaching the recovery delay, the current limiting state returns to normal.

## 10.4 Temperature detection and protection

Number	Function	Definition
1	Temperature detection	(It has 4 cells, 2 MOSFET and 1 AFE chip temperature detection function, and the temperature sampling accuracy is 1°C at room temperature.)
2	Charging high temperature protection	(When the temperature reaches the protection value, close the charging mos and stop charging. When the temperature is lower than the recovery value, the BMS resumes the charge.
3	Charging low temperature protection	(When the temperature reaches the protection value, close the charging mos and stop charging. If the temperature is higher than the recovery value, BMS will resume charge.
4	Discharge high temperature protection	When the temperature reaches the protection value, close the discharge mos and stop discharge. When the temperature is below the recovery value, BMS resumes the discharge.
5	Discharge low temperature protection	When the temperature reaches the protection value, close the discharge mos and stop discharge. If the temperature is greater than the recovery value, the BMS resumes the discharge.

## 10.5 Balancing function

Number	Function	Definition
1	<b>Active balancing</b>	By using an energy transfer circuit, if the maximum voltage difference between any two strings in the current battery pack exceeds 150mV, turn on active balancing; The voltage difference drops to 50mV and the balance is closed (the voltage difference value can be set)
2	<b>Passive balancing</b>	Adopting an energy consuming balancing circuit. Balancing opening condition: Under charging conditions, when the voltage difference between adjacent battery cells reaches the set value, a relatively high voltage balance is opened. When charging is stopped or the voltage difference between adjacent cells is less than the set value, the balance stops. (Differential value can be set).
3	<b>Standby balancing</b>	(When battery is in standby state, the voltage difference of adjacent cells reaches the set value and the balance will be opened.
4	<b>High temperature balancing prohibited</b>	When the temperature reaches the high temperature protection , stop balancing.

## 10.6 Power dissipation

Number	Working state	Power dissipation
1	The standby state and current limiting board is off	≤40mA
2	The standby state and current limiting board is on	≤60mA
3	Turn off / sleep	≤0uA
4	HMI touchscreen	≤5mA

## 10.7 History record

Number	Function	Definition
1	Historical alarm data storage	Can store 50 alarm records. Adopting the first in, first out principle, records exceeding 50 will overwrite early data for storage, and the stored content can be read by the PC software

## 10.8 Pre-charge

Number	Function	Definition
1	Pre-charge	After turn on the inverter, a short circuit protection will be triggered, and all MOS will be immediately turned off, enabling the pre-charging function. After the inverter capacitors are charged fully, the inverter can start up normally, the pre charging function is turned off, and the MOS returns to normal.

## 10.9 Inverter protocol

The BMS now is compatible with the following inverter brand, and do bespoke solutions.

(Note: due to different version of the inverters, some existing inverter may not be communicated with the BMS)

		
		
		
		
		
		
		And more
		

### 10.10 External Switch (Optional)

Number	Function	Definition
1	External switch	BMS itself has its own switch, in order to manage the battery inside a cabinet, can add external switch and use alone

### 10.11 Dry contact (Optional)

Number	Function	Definition
1	2 -4 pins	Often closed, emergency stop

### 10.12 HMI touch screen

Number	Function	Definition
1	HMI touch screen	BMS comes with HMI touch screen function, which can be used by

		<p>connecting the display screen to BMS; The HMI touch screen can select the inverter protocols and display information such as alarms, real-time discharge current, and single cell voltage. (Please refer to the appendix for the English abbreviation comparison of alarm records))</p>
	<p>3.5inch and 4.3 inch</p>	

**10.12 HMI touch screen display (can be customized)**

<p>Page 1 Company logo appears when first power on the BMS or wake up from sleep mode.</p>	
--	--

Page 2  
 Battery module overall  
 information as shown  
 on the right.

**PACK- 1**

Voltage: 56.0 V  
 Current: 1.0 A  
 Capacity: 10.0 Ah  
 Status: Charge  
 Balancing: ON

10%

Page 3  
 Battery cell voltages

**PACK- 1 Cell voltage**

01: 3281 mv	09: 3290 mv
02: 3281 mv	10: 3289 mv
03: 3288 mv	11: 3288 mv
04: 3289 mv	12: 3287 mv
05: 3290 mv	13: 3286 mv
06: 3291 mv	14: 3285 mv
07: 3292 mv	15: 3286 mv
08: 3291 mv	16: 3287 mv

Page 4  
 7 ways of temperature  
 sensors.

**PACK- 1 Internal temperature**

BMS: 16.0 °C      Pack: 16.7 °C  
 Cell1: 16.2 °C      Cell2: 17.0 °C  
 Cell3: 16.4 °C      Cell4: 17.3 °C  
 Environment: 17.6 °C

Page 5  
Alarm and history

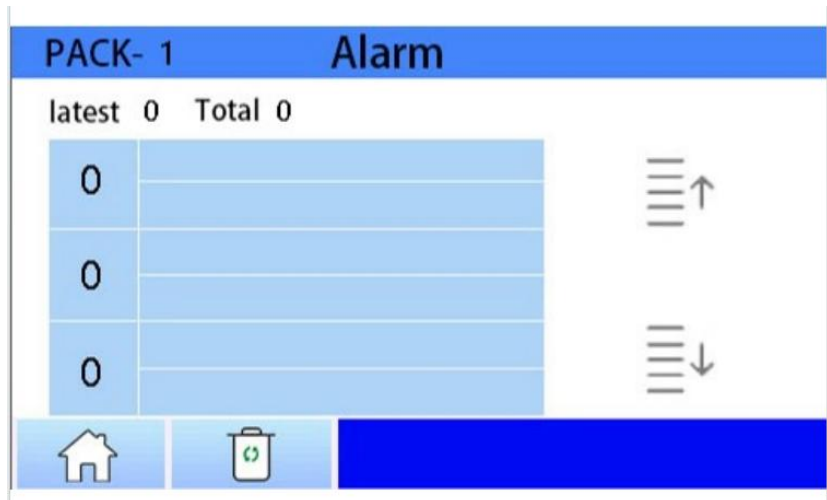

Page 6  
Protocol selecting page,  
more than 20 brands.

Input battery address  
here, select 1 and  
connect to inverter as a  
master Battery,  
2<sup>nd</sup> battery select 2  
3<sup>rd</sup> battery select 3  
And so on,  
Max support **30**  
**batteries** in parallel

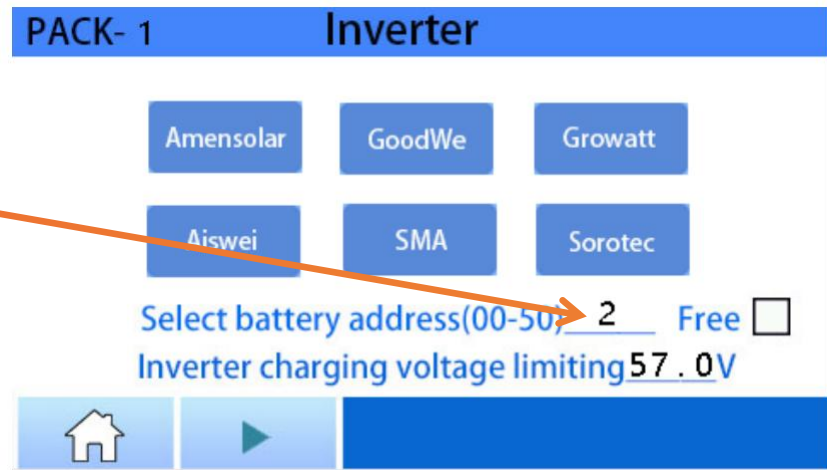

## Master BMS touchscreen page

The BMS master battery touchscreen can work as a master display, show the system parameter, and also show details of every slave batteries.

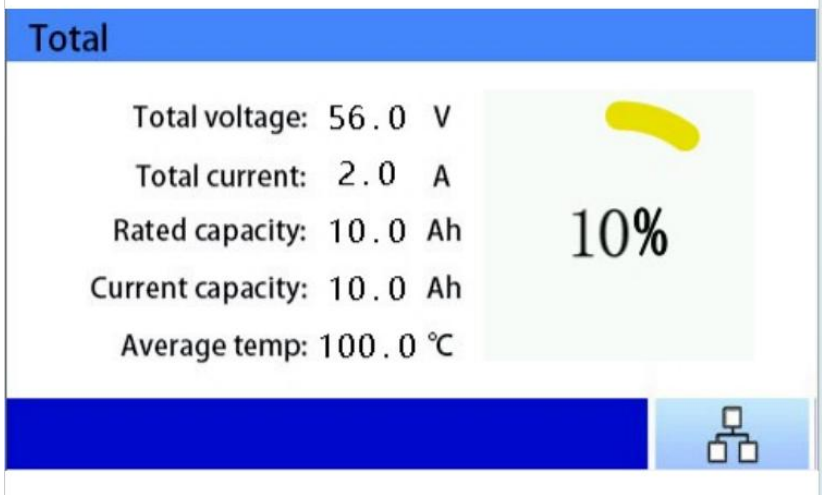
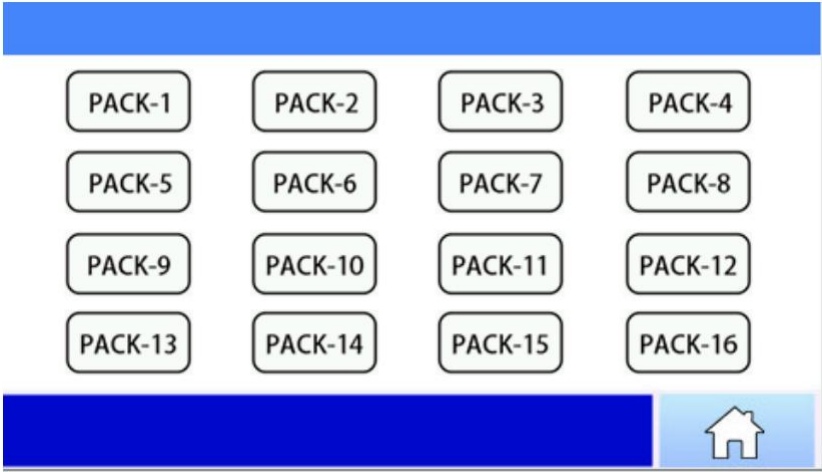
<p>Page 1 of the master battery display.</p> <p>Can show the system battery data like right picture.</p>	 <p>The screenshot shows a blue header with the word 'Total'. Below it, the following data is displayed: Total voltage: 56.0 V, Total current: 2.0 A, Rated capacity: 10.0 Ah, Current capacity: 10.0 Ah, and Average temp: 100.0 °C. To the right of the text is a green battery icon with a yellow bar and the text '10%'. At the bottom right, there is a blue bar with a white icon of a battery pack.</p>
<p>Page 2</p> <p>Every slave batteries data, including master battery.</p> <p>By touch the PACK number, can see the individual battery data.</p>	 <p>The screenshot shows a blue header. Below it, there is a grid of 16 buttons labeled 'PACK-1' through 'PACK-16' arranged in four rows and four columns. At the bottom right, there is a blue bar with a white house icon.</p>

## 11. Notes

- Static electricity should be noted during assembly and use. Do not touch the conductive part of the BMS by hand. If has to, release the static electricity of the body. The soldering iron used in welding and the electric tools used in assembly must be well grounded without any leaking. BMS force shall be prevented during assembly and not damage electronic components.)
- To ensure not damage BMS during assembling, it is required to follow the following steps for installation operation:
  - Assemble the BMS :The power on sequence of the BMS is from B -, JA1, JA2, JP2, JP3, B+, JP1 (if



- any), and P -; Charge or activate by pressing the power button after power on;
- Disassemble the BMS, first disconnect the charger or load, turn off the BMS, and then remove it in the order of P -, JP1 (if any), B+, JP3, JP2, JA2, JA1, B -.)
  - Please follow the design parameters and conditions of use, and shall not exceed the value in this specification, otherwise the BMS may be damaged and lose warranty.
  - Welding: The temperature of the iron is less than 280 degrees. The time of welding the same component should not exceed 10 seconds. Do not use acid flux.
  - Storage: If the battery pack is stored for a long time, need charge the battery at least every 3 months due to the static current of the BMS and the battery self-discharge. Keep BMS in dry place.
  - Transportation: pay attention to anti-static, waterproof, moisture-proof, avoid extrusion, collision.
  - Maintenance: When the BMS fails, professional personnel should be used for inspection and maintenance.
  - When using in parallel, the slave BMS needs to be restarted after setting the address.

## Appendix

### Screen alarm record English abbreviation comparison

Charging over-current protection	OCC
Charging low temperature protection	UTC
Charging high temperature protection	OTC
Discharge over-current protection	OCD
Discharge low temperature protection	UTD
Discharge high temperature protection	OTD
Single cell overvoltage protection	OV
Single cell undervoltage protection	UV
Short circuit protection	SC
Emergency stop alarm	RPSD Activated
Charge/discharge MOS fault	C-MOSfault/D-MOSfault